

TX-28/25SL1F Operating Instruction

English

←
BACK

EXIT

Panasonic



TX-28SL1F
TX-25SL1F

Colour Television

DIGITAL
8-BIT
Technology



**TOP
TEXT**

Operating
Instructions

WELCOME

Dear Panasonic Customer,

Welcome to the Panasonic family of customers. We hope that you have many years of enjoyment from your new colour television. This is a very advanced television; however, the Quick Start Guide will tell you how to have the TV operating quickly. You can then read the instructions completely and retain them for future reference.

CONTENTS

Warnings and Precautions	2	OSD Language	16
Quick Start Guide	3	Q-Link	17
Basic Controls	4	AV Select and Setup	18
Using the On Screen Displays	5	VCR/DVD Operation	19
Picture Menu	6	Teletext Operation	20
Sound Menu	7	Audio / Video (AV) Connections	22
Setup Menu	8	Via the rear AV1 / AV2 21 Pin (SCART) and RCA Audio Out terminals	22
Tuning Menu	9	SCART and S-Video Terminal Information	22
Tuning Menu – Programme edit	10	Troubleshooting	23
Tuning Menu – Auto Setup	14	For your guidance	24
Tuning Menu – Manual tuning	15	Specifications	24

WARNINGS AND PRECAUTIONS

- This TV set is designed to operate on A.C. 220 – 240V, 50Hz.
- To prevent damage which might result in electric shock or fire, do not expose this TV set to rain or excessive moisture.
- **WARNING : HIGH VOLTAGE !!!**
Do not remove the rear cover as live parts are accessible when it is removed. There are no user serviceable parts inside.
- Avoid exposing the TV set to direct sunlight and other sources of heat.
- The On/Off switch on this model does not fully disconnect the TV from the mains supply. Remove the mains plug from the wall socket when the TV set is not used for a prolonged period of time.
- **CABINET AND PICTURE TUBE CARE**
Remove the mains plug from the wall socket. The cabinet and picture tube can be cleaned with a soft cloth moistened with mild detergent and water. Do not use solutions containing benzol or petroleum. TV sets can produce static electricity, care must be taken whenever touching the TV screen.
- Adequate ventilation is essential to prevent failure of electrical components, we recommend that a gap of at least 5cm is left all around this television receiver even when it is placed inside a cabinet or between shelves.

QUICK START GUIDE

Check that you have the accessories and items shown



Remote Control Transmitter
(EUR511200)



Batteries for
the Remote Control Transmitter.
(2 x R6 (UM3) size)

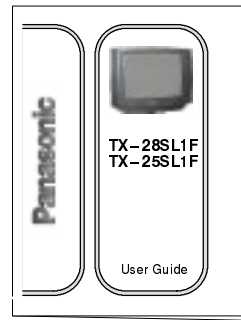

Operating Instruction book
TQB8E2618

TV Guarantee

Remote control batteries

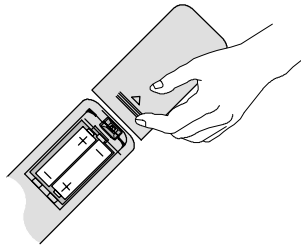

- Make sure that the batteries are fitted the correct way round.
- Do not mix old batteries with new batteries. Remove old, exhausted batteries immediately.
- Do not mix different battery types, i.e. Alkaline and Manganese or use rechargeable (Ni-Cad) batteries.

Quick Start Guide

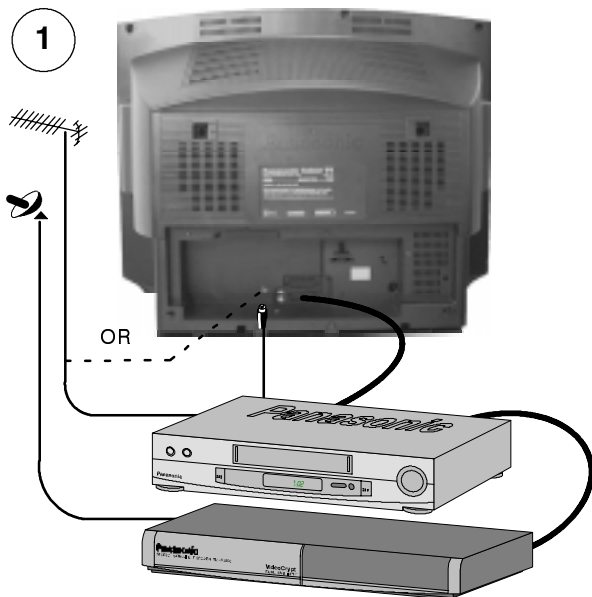

Plug in aerial and connect ancillary equipment

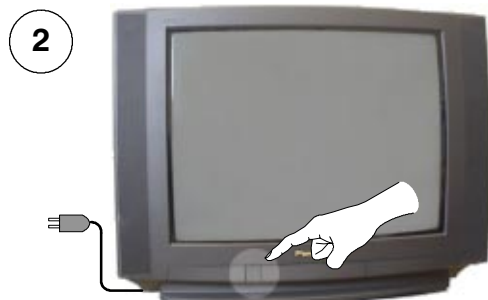

First, ensure that the **VCR is in Standby mode**
Plug in T.V. and switch on



Select your country

For Switzerland and Belgium,
select the desired language

Press the red button

Auto setup will begin,
your stations will be
located and stored.

If a compatible VCR is
connected to the AV2
socket, programme data
will be downloaded to the
VCR via Q-Link.
See page 17.

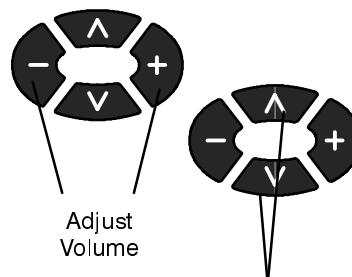
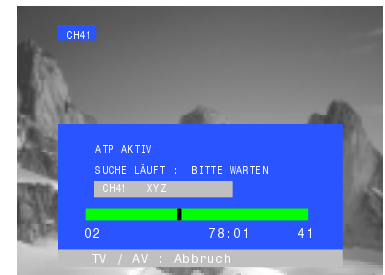
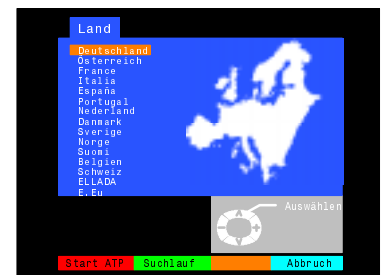

Adjust
Volume

Change Channel



If you are installing a new Q-Link compatible VCR, you can now switch it ON. Downloaded tuning data will match the television's. If you are installing a new NEXTVIEWLINK compatible VCR, you will need to initiate download manually. See the VCR handbook for details.

- If the VCR has not accepted download data from the TV, you may need to select the Download option from the VCR's menu.
- If Q-Link is not operating correctly, check it is connected to the television's AV2 socket, the SCART lead is a "full function" type, and the VCR is compatible with Q-Link, NEXTVIEWLINK or similar technologies. Ask your dealer for further details.
- For further information on Q-Link and connecting equipment, see pages 17 and 22.

BASIC CONTROLS : FRONT PANEL AND REMOTE CONTROL



MAINS Power On/Off switch

STR (Normalisation store)
Used to store tuning and other function settings

F (Function select)
Displays the On Screen Display functions, use repeatedly to select from the available functions – Volume, Contrast, Brightness, Colour, Sharpness, Tint (in NTSC mode), Bass, Treble, Balance, and Tuning mode.

Red light indicates Standby mode. Use Standby switch, -, + or 0-9 buttons to switch TV On

TV/AV switch (see page 18)

Increases or decreases the programme position by one. When a function is already displayed, press to increase or decrease the selected function.

Standby ON/OFF switch
Switches TV On or Off standby.

Menu buttons
Press to access the Picture, Sound and Setup menus (see page 5)

Status button
Press to display programme position, programme name, channel number, TV system, time, stereo mode and programme table

Teletext buttons (see page 20)

Direct TV Record button
(see page 17)

Ambience on/off

Programme / channel change buttons (0-9) and Teletext page buttons (see page 20)

Direct Channel Access
During normal TV viewing or when in the Tuning, Programme edit or Manual tuning menus, press and then enter channel number using the numeric buttons

The N button will recall settings stored with STR
STR (Normalisation store)

Sound mute On/Off

Cursor buttons to make selections and adjustments

Switch between viewing TV or AV input (see page 18)

Coloured buttons used for Programme Edit functions (see page 10)
Teletext functions (see page 20)
AV selection (see page 18)

Programme position for selection of two digit programmes (10-99) using numeric buttons

VCR / DVD buttons (see page 19)

The Help button provides a demonstration of On Screen Display menus



USING THE ON SCREEN DISPLAYS

This TV has a comprehensive system of On Screen Display menus to access adjustments and options

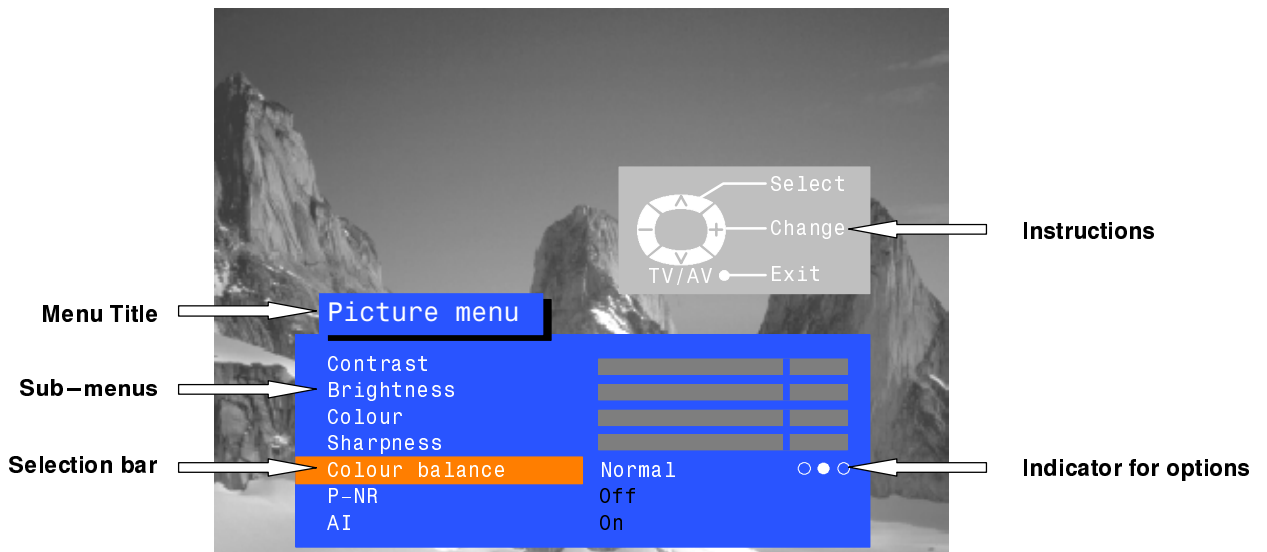

Some selections, for example, **Contrast**, **Brightness**, **Colour** and **Sharpness** will allow you to increase or decrease their level.

Some selections, for example, **Off timer**, allow a choice to be made.

Some selections, for example **Tuning menu**, will lead to a further menu.

The **PICTURE**, **SOUND** and **SET UP** buttons are used to open the main menus and also to return to the previous menu.

The up and down cursor buttons are used to move the cursor up or down the menus.

The left and right cursor buttons are used to access menus, adjust levels or to select from a range of options.

The **STR** button is used to store settings after adjustments have been made or options have been set.

The **TV/AV** button is used to exit the menu system and return to the normal viewing screen.

The **HELP** button will run a demonstration of the menus available. Press the **HELP** button and select one of the options.

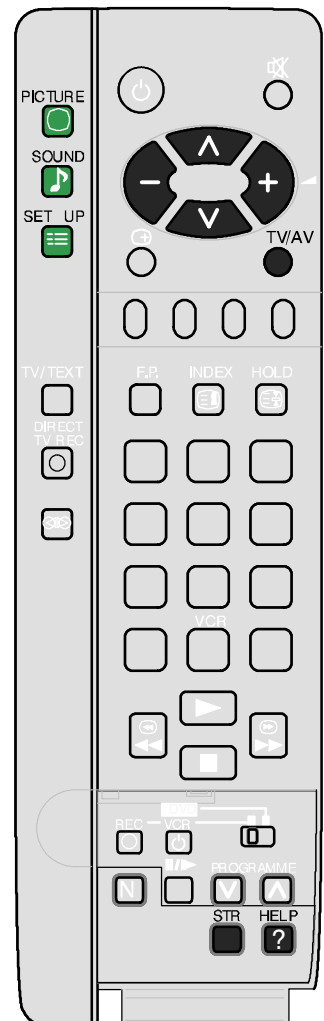
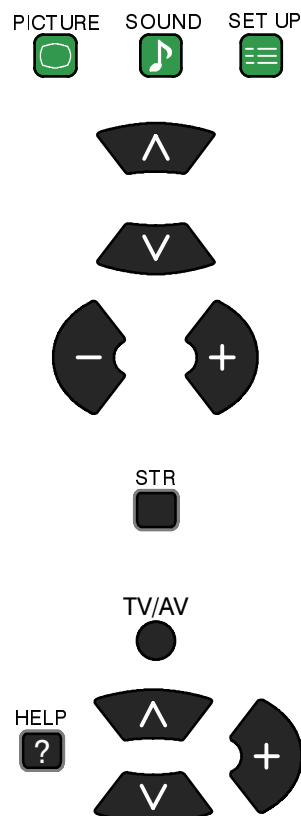

PICTURE MENU

This menu allows you to make adjustments to the picture quality

Open the Picture menu

PICTURE



Move to your choice



Increase or decrease levels or set options



Press the TV/AV button to exit the Picture menu

TV/AV

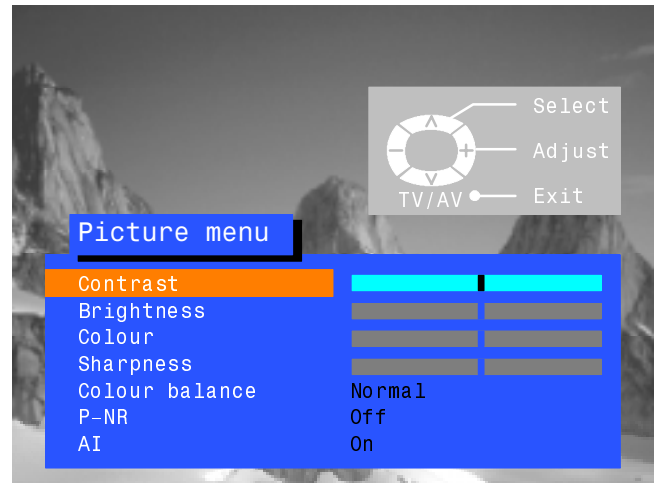

Contrast



Brightness



Colour



Sharpness



Tint

The Contrast, Brightness, Colour and Sharpness levels can be adjusted to suit your own preferences and the viewing conditions.

The Tint adjustment will only appear as a menu item if you have an NTSC signal source connected to the TV and will allow adjustment of the hue.

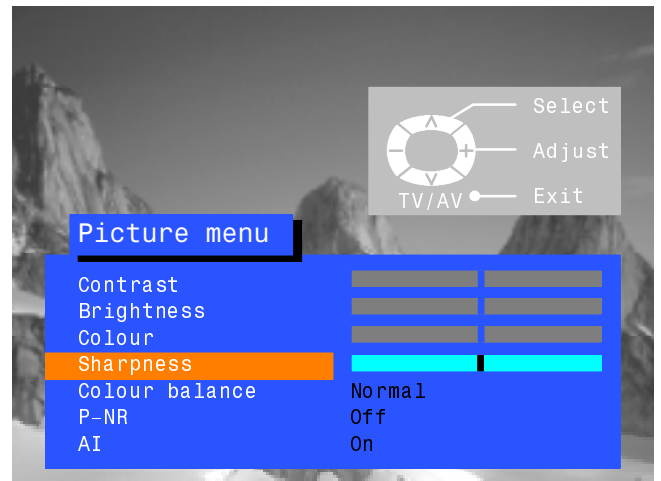

Colour balance



The Colour balance setting allows you to set the overall colour tone of the picture.

P-NR



P-NR will automatically reduce unwanted picture interference.

AI



The AI setting automatically analyses the incoming picture and processes it to give improved contrast, optimum depth of field and vivid colour tones.



SOUND MENU

The Sound menu will allow you to set your personal preferences for all aspects of sound quality

Open the Sound menu



Move to your choice



Increase or decrease levels or set options



Press the TV/AV button to exit the Sound menu

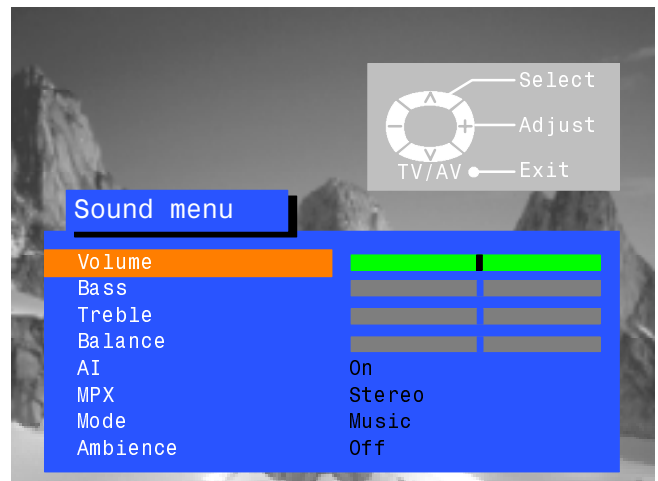

Volume

The Volume adjustment sets the overall output volume.



Bass

Bass adjustment will emphasise the lower, deeper frequencies and can be increased or decreased.



Treble

Treble adjustment will emphasise the sharper, higher frequencies and can be increased or decreased.



Balance

Balance affects the levels of sound between the left and right speakers. Adjustment can be made so that the level from the speakers will suit your listening position.

AI



The AI setting automatically analyses the incoming sound signal and processes it to give lower noise and optimum tone for the programme material.

MPX



MPX will usually be set to Stereo to provide the best reproduction, however if reception deteriorates or if the service is not available then it is advisable to switch to Mono. Mono (M1) and (M2) can also be selected if signals are being transmitted.

Mode



The sound can be improved during Music or Speech mode by selecting the appropriate function.

Ambience



Ambience provides a dynamic enhancer to simulate improved spatial effects.



SETUP MENU

The Setup menu provides access to various advanced features and also to the Tuning menu

Open the Setup menu



Move to your choice



Increase or decrease levels, set options or access further menus



Press the TV/AV button to exit the Setup menu

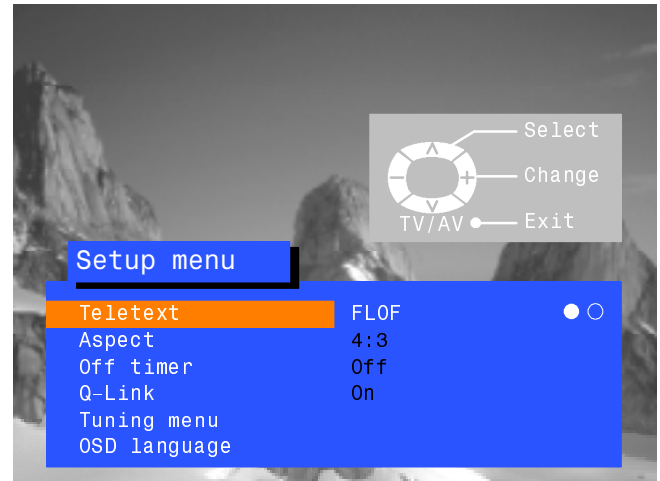

● ○
Teletext

The Teletext option allows you to choose between TOP/FLOF or LIST mode. See page 20.

● ○
Aspect

Aspect allows you to view widescreen programme material with the correct aspect ratio (16:9).

● ○ ○ ○ ○ ○ ○ ○
Off timer

Off timer will switch the TV off within a preset time which you can choose from between 0 to 90 minutes in 15 minute intervals.

○ ●
Q-Link

Q-Link allows you to enable or disable data communication with a compatible VCR. See page 17.

Tuning menu

The Tuning menu provides an entry to many other features including Programme edit, ATP, Fine tuning, Manual tuning, Colour system and Volume correction. See page 9.

OSD Language

OSD Language allows you to select the language used for On Screen Displays. See page 16.

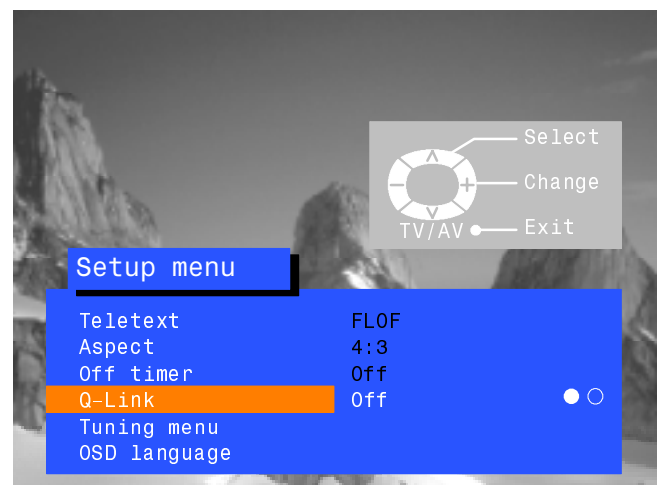
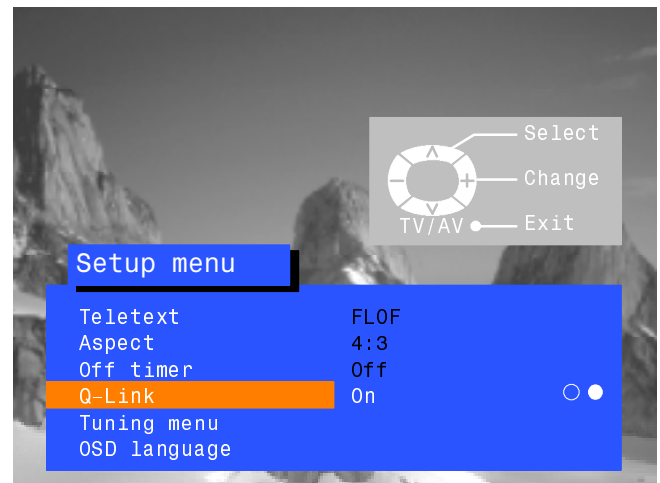

TUNING MENU

The Tuning menu provides access to manual, automatic and fine tuning menus

Open the Setup menu

SET UP



Move to Tuning menu



Access Tuning menu



Move to your choice



Increase or decrease levels, set options or access further menus



Press the TV/AV button to exit

TV/AV

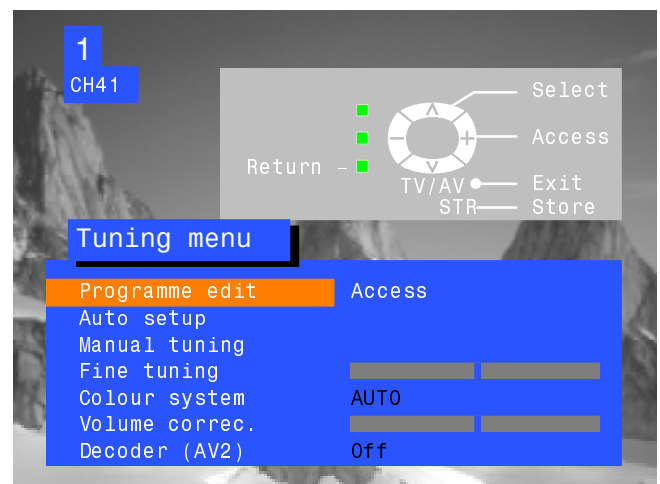
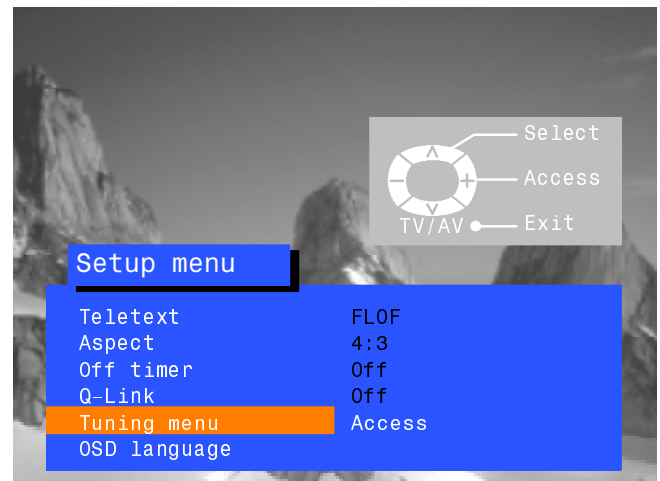
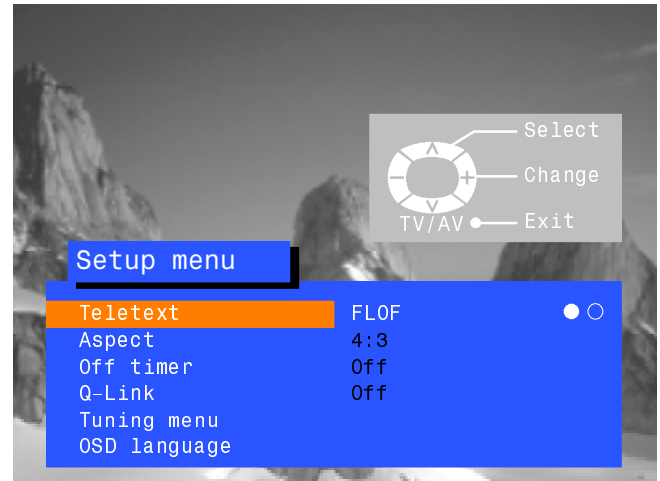

Programme edit

Accessing the Programme edit menu will allow stations to be moved, added, deleted, named or locked and provides access to the TV – system. See page 10.

Auto setup

The Auto setup menu allows you to automatically retune the TV. See page 14.

Manual tuning

The Manual tuning menu allows individual programme positions to be tuned manually. See page 15.

Fine tuning

Stations can be finely tuned using the Fine tuning adjustment.

Colour system



The Colour system menu allows you to decide the correct choice of transmission standard.

Volume correc.

Volume correction allows you to adjust the volume level of individual stations.

Decoder (AV2)



This option is used when a decoder is connected via AV2. Set to On if a scrambled signal is to be processed by the decoder. Set to Off after use.

TUNING MENU – PROGRAMME EDIT

The Programme edit menu allows you to edit the programme position settings

Open the Setup menu

SET UP



Move to Tuning menu



Access Tuning menu



Move to Programme edit menu



Access Programme edit menu



Make required changes
(see sections below)

Press STR button to store changes

STR



If you have finished in the Programme edit menu, press the TV/AV button to exit

TV/AV



To delete an unwanted programme position

Choose the programme position



Press the Red button on remote control



Press the Red button again to confirm



If you have finished in the Programme edit menu, press the TV/AV button to exit

TV/AV

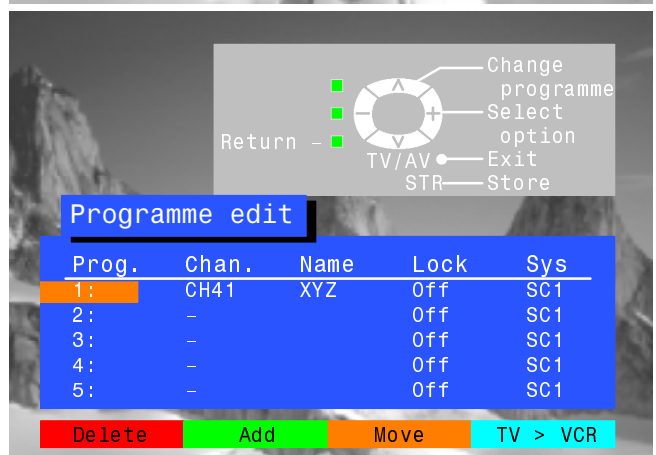
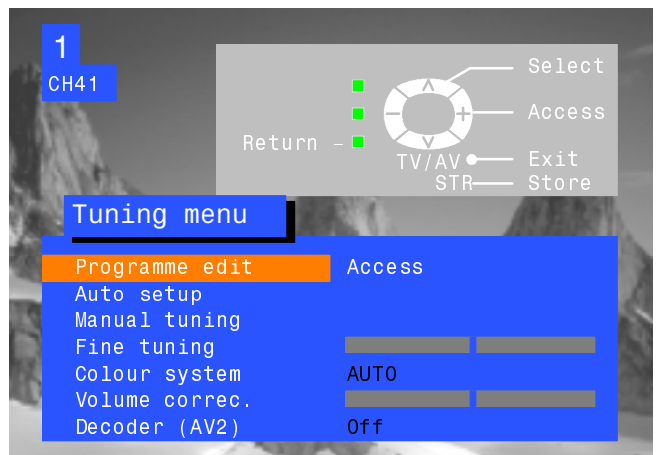
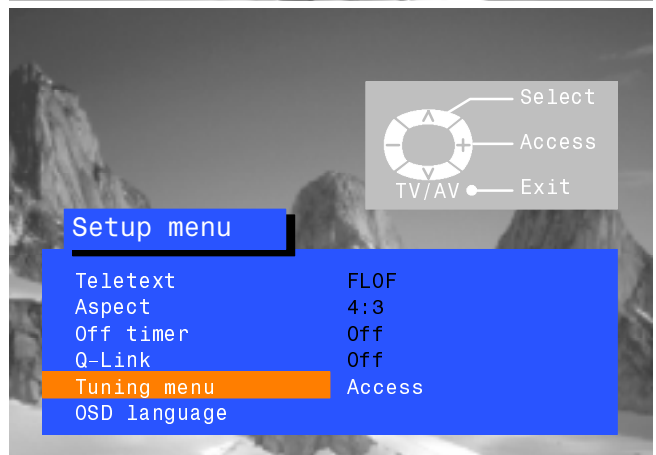
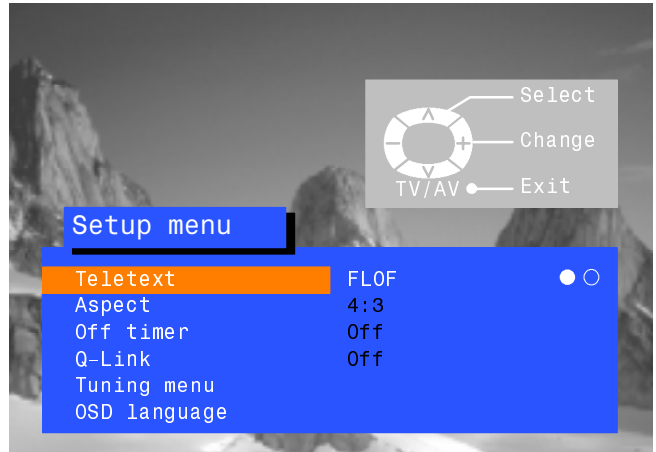

TUNING MENU – PROGRAMME EDIT

To add a programme position

Choose the programme position where the new programme is to be inserted



Press the Green button



Press the Green button again to confirm



This blank programme can then be tuned, named, locked and be allocated your choice of TV-system

Press STR to store



If you have finished in the Programme edit menu, press the TV/AV button to exit

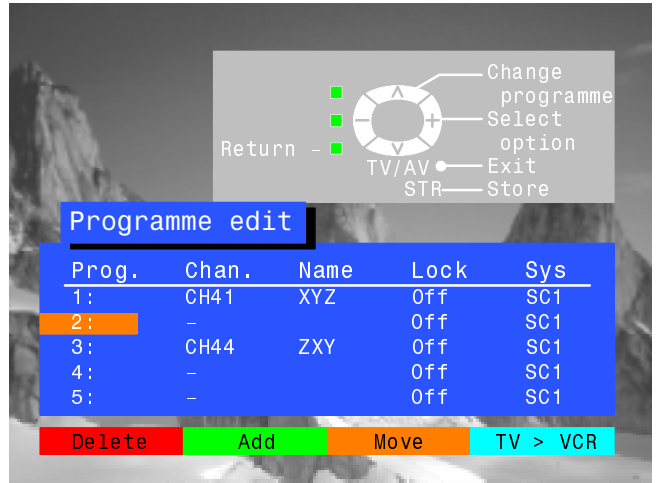

To move a programme to another position

Choose the programme position to be moved



Press the Yellow button on remote control



Choose new position



Press the Yellow button again to confirm



If you have finished in the Programme edit menu, press the TV/AV button to exit

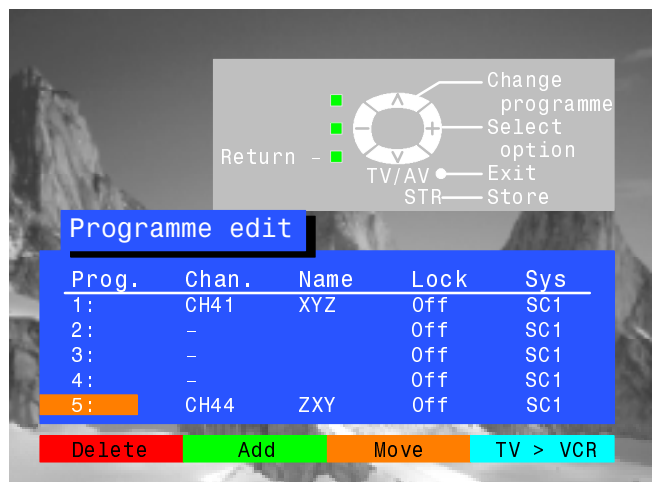
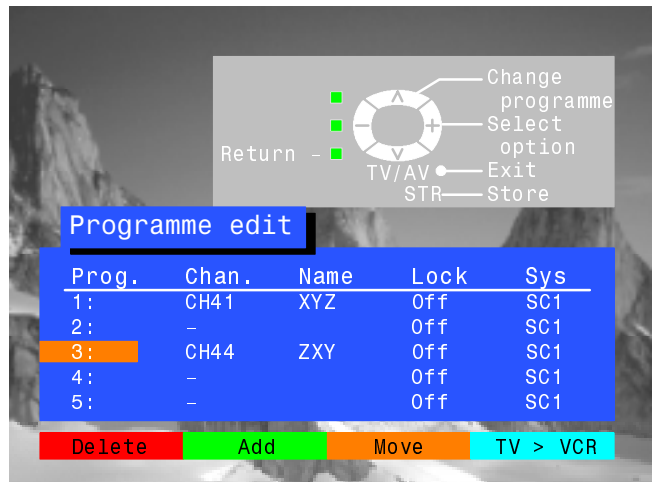

TUNING MENU – PROGRAMME EDIT

To tune a programme position

Choose the programme position



Move to the channel column



Increase or decrease channel number or use the 'C' key for Direct Channel Access (see page 4)



Press STR to store



If you have finished in the Programme edit menu, press the TV/AV button to exit

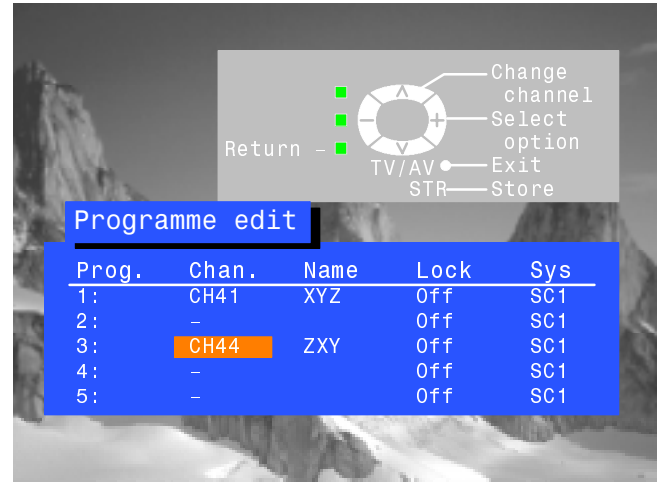

To rename a programme position

Choose the programme position



Move to the Name column



Choose the new character



Move to the next character position



Continue until renaming is done

Press STR to store



If you have finished in the Programme edit menu, press the TV/AV button to exit

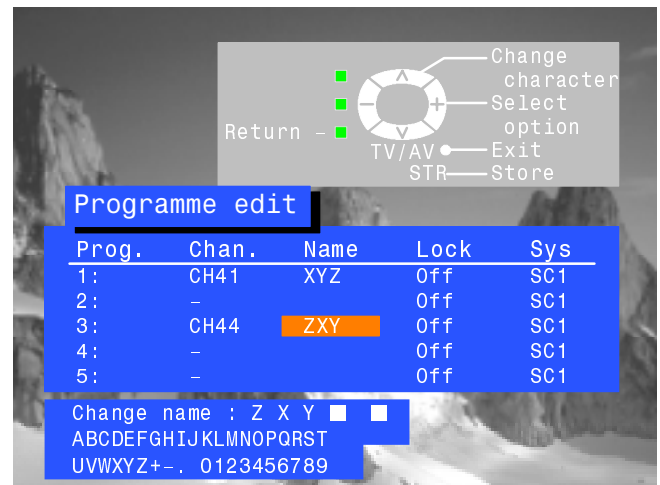

TUNING MENU – PROGRAMME EDIT

To lock a programme position to prevent access

Choose the programme position



Move to the lock column



Choose between lock on or lock off



Press STR to store

STR



If you have finished in the Programme edit menu, press the TV/AV button to exit

TV/AV



Note :

When a programme position is locked, Direct Channel Access using the 'C' and numeric keys on the remote control is not available.

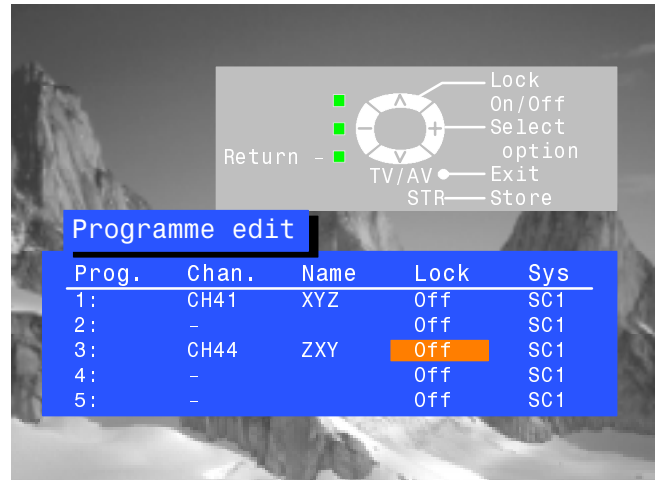

To change the TV-system for a programme position

Choose the programme position



Move to the Sys column



Choose the required sound system:

SC1 : PAL B, G, H / SECAM B, G

SC2 : PAL I

SC3 : PAL D, K / SECAM D, K

F : SECAM L/L'



Press STR to store

STR



If you have finished in the Programme edit menu, press the TV/AV button to exit

TV/AV

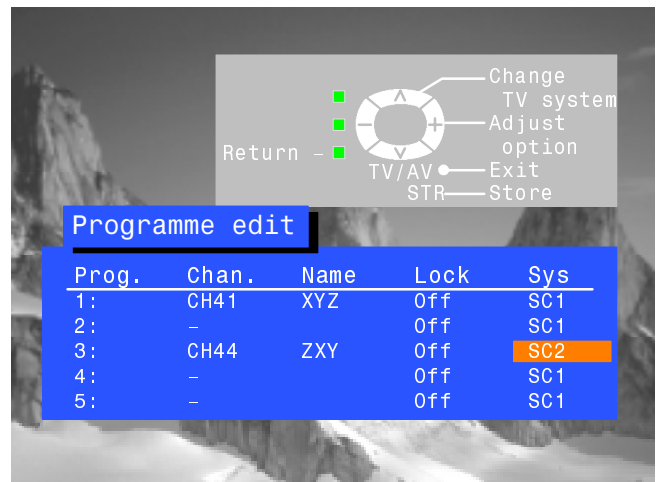

To copy programme information to a compatible VCR connected to AV2

Move to the Prog. column



Press the Blue button on the remote control.

Programme data will now be sent to the VCR. This might take a few seconds, depending on the number of stations stored.

















If you have finished in the Programme edit menu, press the TV/AV button to exit

TV/AV



TUNING MENU – AUTO SETUP (ATP)

The Auto setup menu will allow you to automatically retune the TV to your local stations.
It is useful if you move to a different region

- Open the Setup menu 
- Move to Tuning menu  
- Access Tuning menu  
- Move to Auto setup  
- Access Auto setup  
- Press to confirm start  
- Select your country  
- Press to start Auto setup (ATP)  

The TV will search for, locate and sort into order your local stations. If a compatible VCR is connected via the AV2 socket, programme data will be sent to the VCR via Q-Link (see page 17).



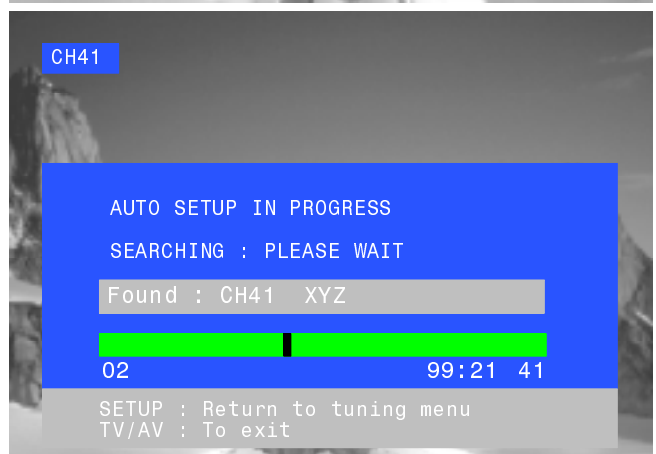
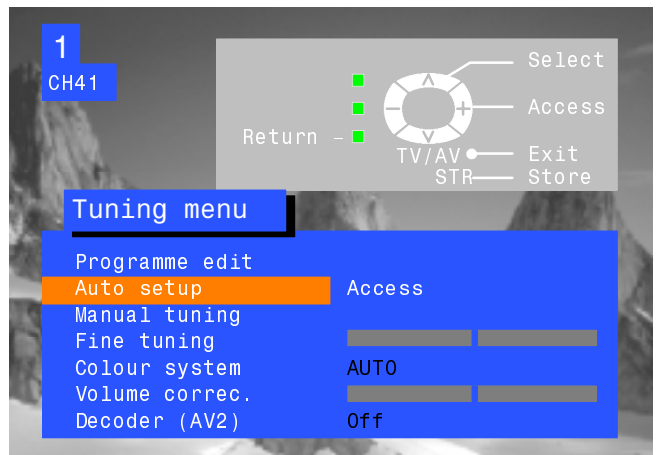
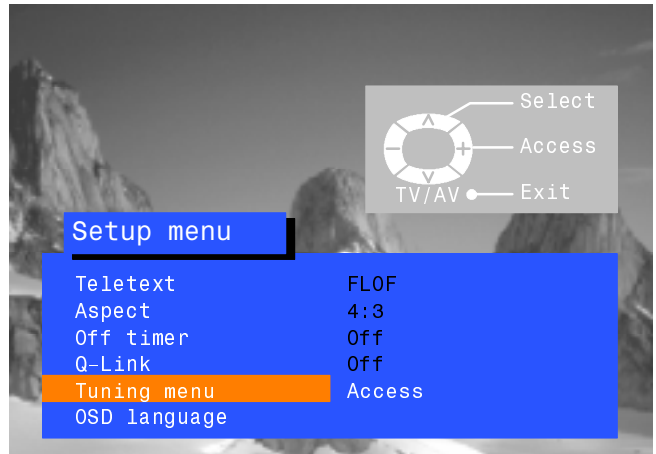









Once this operation is completed the TV will display programme position 1.



TUNING MENU – MANUAL TUNING







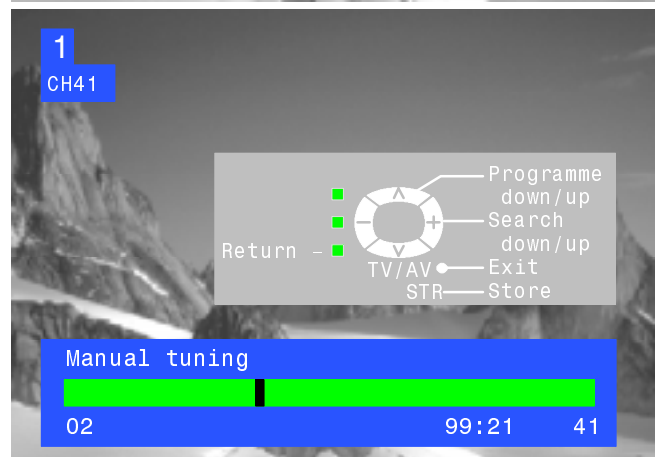
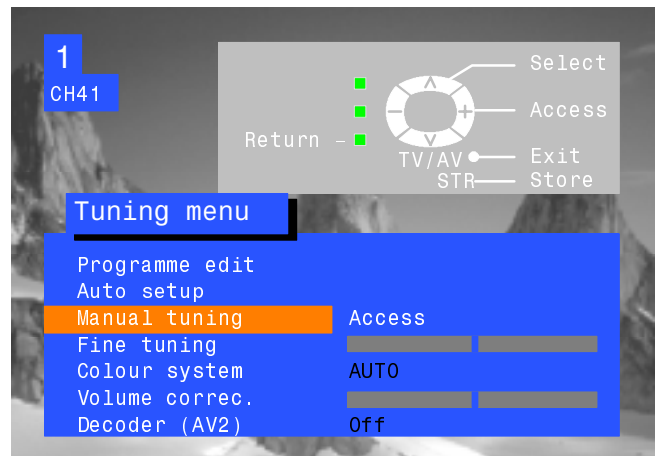

Manual tuning of the Programme positions is available either from the On Screen Display menu or from the front panel controls

Manual tuning menu

- Open the Setup menu 
- Move to Tuning menu 

- Access Tuning menu 
- Move to Manual tuning 

- Access Manual tuning 
- Select the programme position to be tuned 

- Start tuning 
- When the desired programme is found, press STR to store 
- Press the TV/AV button to exit. 

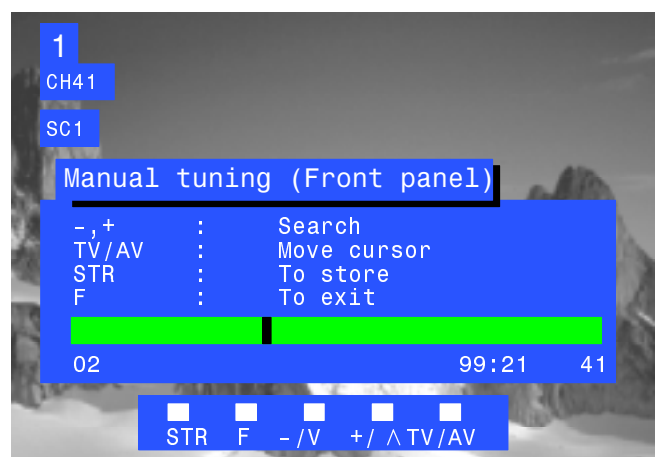

Manual tuning (Front panel)

- Press the F button (Front panel) until "Tuning mode" is reached 
- Press the - or + button to access Tuning mode 

- Press the TV/AV button to move between "Change programme", "Search" or "Change TV system" 
- Press the - or + button to change programme position, start search, or alter TV system 

- When the desired station is found, press STR to store the changes 
- Repeat above procedure to tune additional programmes or press the F button to exit 



OSD LANGUAGE

When you first installed the TV the On Screen Display language was set according to your choice of country. If you wish to use a different language then it can be chosen from the OSD language menu

Open the Setup menu



Move to the OSD language menu



Access the OSD language menu



Move to your choice



Press the TV/AV button to select and exit

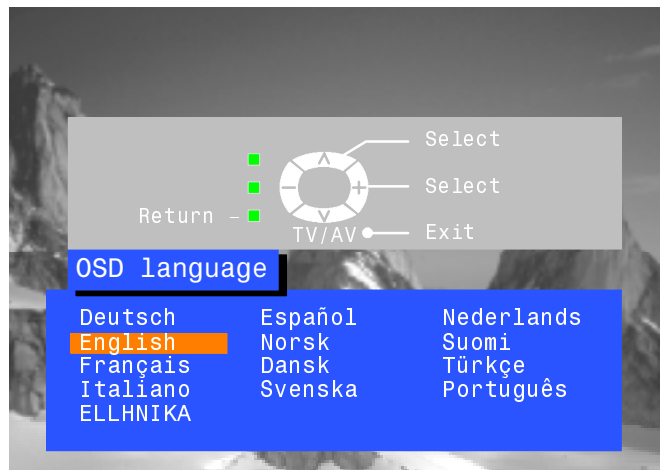
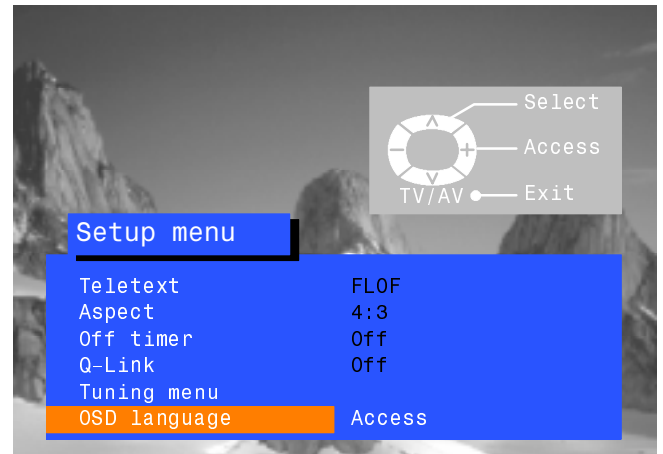

Q-LINK

Q-Link allows the television to communicate with your VCR

Open the Setup menu



Move to Q-Link



Confirm Q-Link is set to "On"



Press the TV/AV button to exit

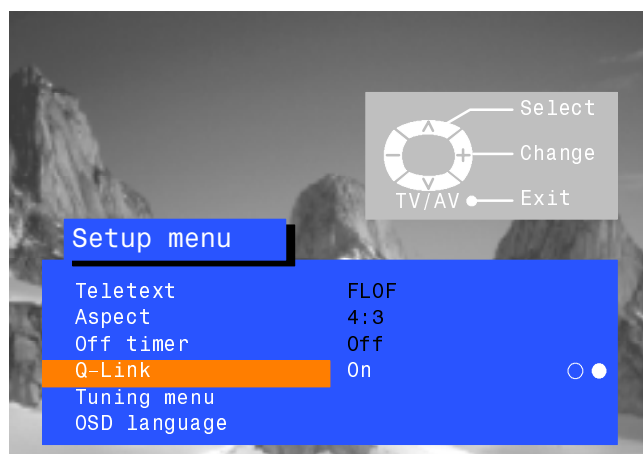

The VCR must be connected with a SCART lead (full function type) attached between the AV2 socket of the television and the appropriate socket on your VCR. See the VCR handbook for further information. Q-Link, NEXTVIEWLINK or similar technology allows the television to instruct a **compatible VCR** to record the programme that is currently being displayed on screen, regardless of the programme position set on the VCR, thus simplifying the process of recording programmes.

To record the programme you are currently watching



Press the DIRECT TV REC button on the remote control

If the VCR is off, it will automatically switch on when you press the DIRECT TV REC button.

A message, sent from the VCR, will appear on screen showing what is being recorded, or if it is not possible to record:

VCR recording preset prog

VCR recording own tuner

VCR is recording the programme signal from its own tuner. If you wish you can switch off the TV and leave the VCR recording in the normal way.

VCR recording TV source

VCR is recording the programme signal from the television. You must not change programme position or switch off the TV: if you do, the VCR will automatically stop recording and switch off.

No recording TAPE IS PROTECTED

The write protection tab on the back of the cassette has been removed.

Examples of other messages that might be displayed are:

No recording NO TAPE

No recording VCR IS PLAYING

VCR Recording VCR external

No recording VCR ALREADY RECORDING

No recording TAPE MAY BE DAMAGED

No recording NO SOURCE AVAILABLE

To share tuning information

To ensure correct recordings are made, the television and VCR should share tuning information – see page 13.

- Whenever the Auto setup (ATP) function is used, tuning data will be downloaded to the VCR.

Auto Power functions

With Panasonic Q-Link VCRs these additional features are available:

- If you insert a tape in your VCR and press the Play button, the television will automatically switch on and select the AV2 input so you can view the tape.
- If you switch off the television whilst the VCR is in Stop, Fast Forward or Rewind modes, the VCR will switch off automatically.

To turn off Q-Link communication

If you do not wish to use the Q-Link feature, go to the Setup menu and set the Q-Link option to "Off". See page 8.

Important Note:

Not all VCRs support this type of data communication system. Some may support certain features, but not others. See the VCR handbook for further information.

If Q-Link is inoperative, first confirm that your SCART lead is a full function type. Ask your dealer for further details.

AV SELECT AND SETUP

The AV Select menu will allow you to choose which AV source to view

Press the TV/AV button



Press the appropriate coloured button of remote control (whilst the options remain on screen)



The options will disappear

You may wish to make adjustments to the Setup or Sound menus

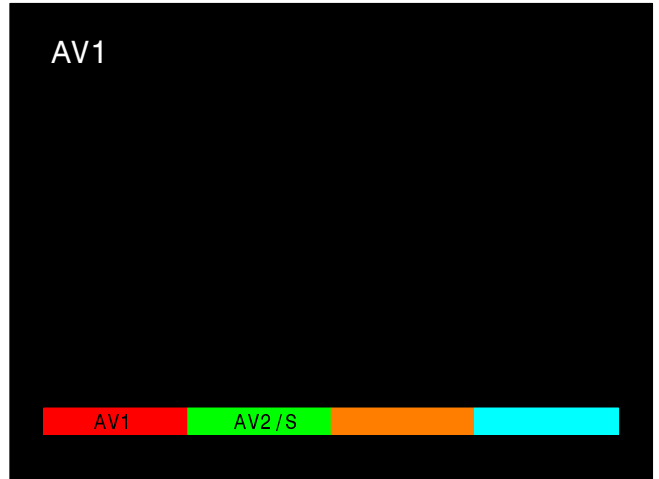

Setup menu

Open the Setup menu



Move to your choice



Access adjustments or options



Press the TV/AV button to exit

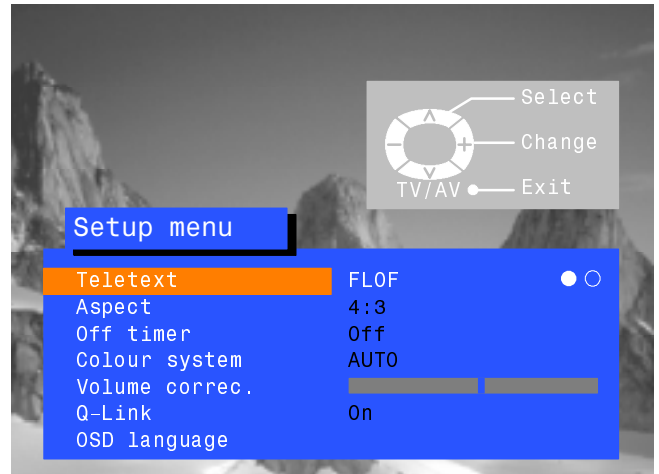

Sound menu

Open the Sound menu



Move to your choice



Access adjustments or options



Press the TV/AV button to exit

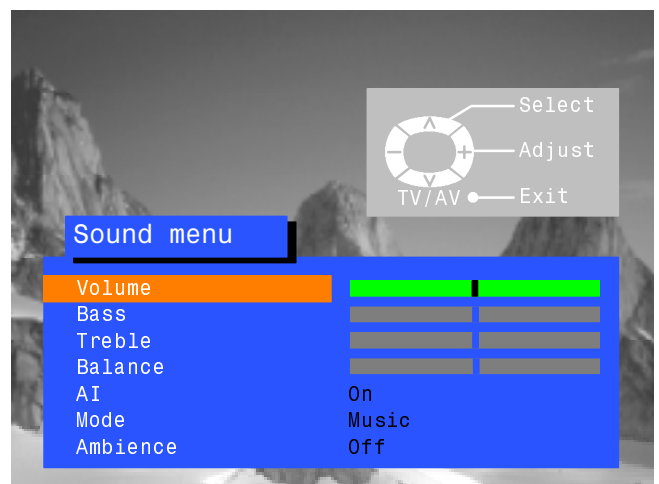

VCR / DVD OPERATION

The Remote Control is capable of operating some functions of selected Panasonic VCRs and DVD (Digital Versatile Disc) equipment. Some VCR and DVD equipment have different functions, so to ensure compatibility please refer to the equipment's instruction book or consult your dealer for details.



Standby

Press to switch the VCR or DVD to standby mode. Press again to switch back on.



VCR / DVD switch

Use this switch to select whether controls operate DVD equipment or your VCR.



Play

Press to playback the tape or DVD.



Stop

Press to stop the tape or DVD.



Skip / Fast Forward / Cue

VCR: Press to fast forward the tape. In Play mode, press to view the picture rapidly forward.
DVD: Press once to skip to the next track. In play mode press and hold to view the picture rapidly forward.



Skip / Rewind / Review

VCR: Press to rewind the tape. In Play mode, press to view the picture rapidly in reverse.
DVD: Press once to skip to the previous track. In play mode press and hold to view the picture rapidly in reverse.



Pause / Still

Press in playback mode, the picture will pause. Press again to restart play.



Programme Up / Down

Press to increase or decrease the VCR programme position by one.



Record

Press this button to start recording.

TELETEXT OPERATION

- Teletext features may vary depending on the Broadcasting Companies and is only available if the channel selected is transmitting Teletext.
- Pressing the Picture button whilst in Teletext operation will display the contrast function with a cyan bar, press ◀ ▶ to alter the setting as required.
- Pressing the Setup button whilst in Teletext operation will display special function options at the bottom of the screen.
- When in Teletext mode, the volume may still be altered to the desired listening level.

What is LIST mode?

In LIST mode, four differently coloured page numbers are situated at the bottom of the screen. Each of these numbers can be altered and stored in the TV's memory.

What is FLOF (FASTEXT)?

In FASTEXT mode, four differently coloured subjects are situated at the bottom of the display. To access more information about one of these subjects, press the appropriately coloured button. This facility enables fast access to information of the subjects shown.

What is TOP Teletext?

TOP Teletext makes the task of selecting the desired Teletext pages easier and shorter. In fact page access time is almost instantaneous, just press the button and the page appears.

How does it work?

TOP uses the four coloured buttons, Red, Green, Yellow and Blue to select the following information.

- To move between subject blocks (SPORT for example) use the Blue button. Within this SPORT topic it is possible to select different groups such as Tennis, Football, Baseball etc, by using the Yellow button. When the last group within the block is reached, the yellow button moves to the next block.
- The Green button will select the next available page UP.
- The Red button will select the next available page DOWN.

What are the advantages?

- Page selection at the touch of a single button.
- Easy to use step – by – step selection of the topical subject.
- Reduction of waiting time.
- If non-existent page number is entered, a question mark will appear at the bottom of the screen.
- Page status line at bottom of screen so you always know which button will take you to the desired information.

TV/TEXT



TV / Teletext mode

Press the **TV/TEXT** button.
The screen will display the Teletext page.
Press again when you wish to return to TV. mode.



Page Selection

Pages can be selected in two ways :

- a. Press the Up / Down buttons to increase or decrease the page number by one.
- b. By entering the page number, using 0 –9 on the remote control.

SET UP



Full / Top / Bottom

Press the **SET UP** button to display special functions, followed by the **Green** button.
Press the **Green** button again to expand the BOTTOM half.
Press again to return to normal (FULL) size.

SET UP



Reveal

Press the **SET UP** button to display special functions, followed by the **Red** button to reveal hidden words e.g. quiz page answers. Press again to hide.



Red / Green / Yellow / Blue buttons

In TOP or FASTEXT mode these correspond to the differently coloured subjects.
In LIST mode they correspond to the differently coloured page numbers.

STR



List Store

In LIST mode the four page numbers can be altered for channel positions 1 – 25 only.
To do this, press one of the coloured buttons and enter the new page number.
Press and hold **STR**, the page numbers will change colour.

TELETEXT OPERATION

It is not possible to change the programme position when in News flash, Update or Sub Coded Page Access operation.

HOLD



Hold

To hold the Teletext page when viewing multi – page information.
Press again to return to automatic page update.

F.P.



Favourite Page (F.P.)

Stores a favourite page in memory for instant recall. To store such a page, the TV must be in LIST mode, and the programme position must be from 1 – 25. Press the **Blue** button, select the page number, then press and hold the **STR** button. The page number is now stored.
Press **F.P.** to recall this page.

SET UP



Update Display

Press the **SET UP** button to display special functions, followed by the **Yellow** button to view the TV picture whilst searching for a Teletext page.
When found, the screen will display the page number at the top left.
Press the **Yellow** button to view the page.
Press **TV / TEXT** again to return to normal TV operation.

News Flash

When a news flash page has been selected, press **SET UP, Yellow**, to view the TV picture. When an update is received, the page number will be displayed on screen.
Press the **Yellow** button to display the News Flash
Press **TV / TEXT** to return to normal TV. operation.

Update

Press **SET UP, Yellow** to see the update of information on certain pages.
When an update is received, the page number will be displayed at the top left of the screen.
Press the **Yellow** button to view the page.
Press **TV / TEXT** to return to normal TV. operation.

SET UP



Sub Coded Page Access

When Teletext information exceeds more than one page, it may take some time for the automatic changing of the sub pages to reach the sub page you require.
It is possible to enter your required sub page and continue watching the normal programme until the correct sub page is found.
Select the required page number using buttons 0 – 9.

Press the **SET UP** button followed by the **Blue** button; T**** will be displayed at the top right of the screen.

Enter desired sub page number before the T**** disappears.
To select page 6 enter 0, 0, 0 and 6.

(If in LIST mode, a 'T' will appear in the current box at the bottom).

Press the **Yellow** button to view a normal TV programme.
(Press **SET UP, Yellow** in LIST mode).

When the page is available, press the **Yellow** button to view the page.
To clear the page perform one of the following :

- Press **SET UP**.
- Select a new page number.
- Press **TV/TEXT** to return to normal TV operation.

INDEX



Index

Press **INDEX** to return to the main index page.
Depending on the way information is transmitted, this may have to be pressed more than once to return to the main index page.

AUDIO / VIDEO CONNECTIONS

Rear AV1/AV2(S) 21 Pin SCART and RCA Audio Out Terminals

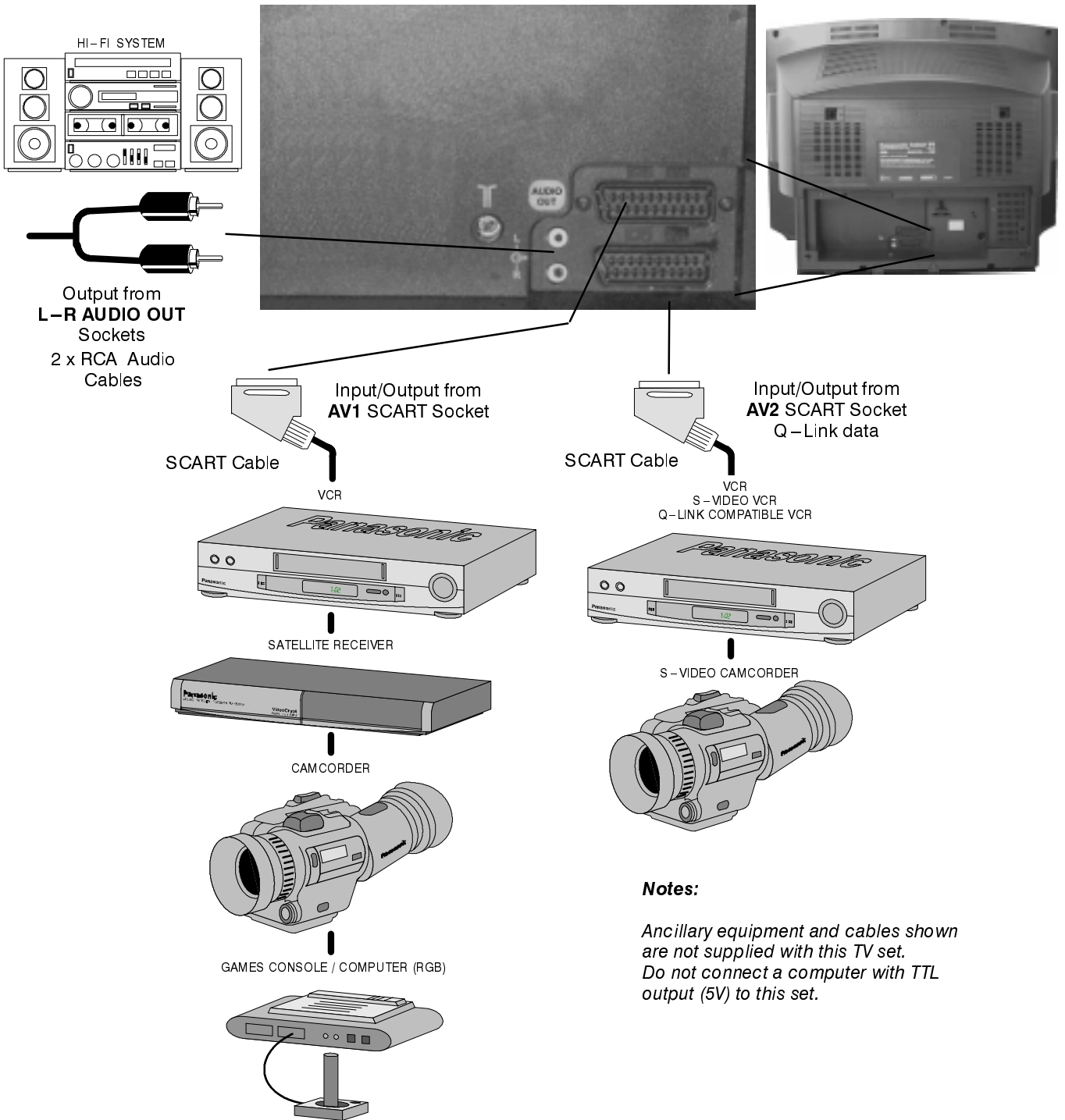

Notes:

Ancillary equipment and cables shown are not supplied with this TV set.
Do not connect a computer with TTL output (5V) to this set.

■ SCART Terminal Information

AV1 21 pin SCART terminal

Socket Earth	21	20	CVBS in (video)
CVBS out (video)	19	18	RGB status earth
CVBS earth	17	16	Status RGB
Red in	15	14	Earth
Red earth	13	12	--
Green in	11	10	--
Green earth	9	8	Status CVBS
Blue in	7	6	Audio in (L)
Blue earth	5	4	Audio earth
Audio out (L)	3	2	Audio in (R)
Audio out (R)	1		







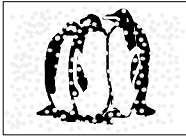
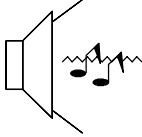
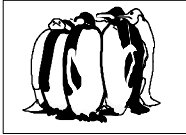
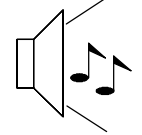
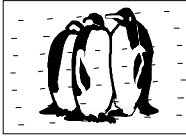
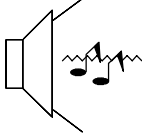
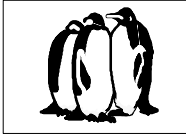
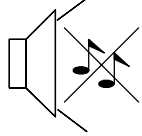

AV2 21 pin SCART terminal

Socket Earth	21	20	CVBS in (video)
CVBS out (video)	19	18	Earth
CVBS earth	17	16	--
S.C. - In	15	14	Earth
Earth	13	12	--
--	11	10	--
Earth	9	8	Q-Link data
--	7	6	Status CVBS
Earth	5	4	Audio in (L)
Audio out (L)	3	2	Audio earth
Audio out (R)	1		Audio in (R)

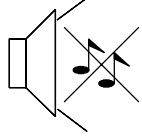
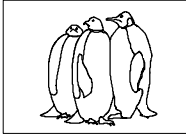
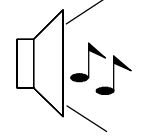
Suitable inputs for AV1 include RGB (Red/Green/Blue).

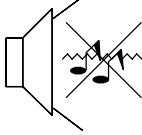
AV2 - Pins 15 and 20 are dependent on AV2 S-VHS / VIDEO switching.

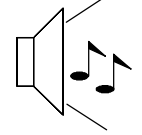
TROUBLESHOOTING

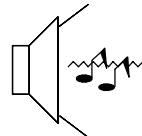
Symptoms		Checks
Picture	Sound	
 Snowy Picture	 Noisy Sound	Aerial location, direction or connection
 Multiple Images	 Normal Sound	Aerial location, direction or connection
 Interference	 Noisy Sound	Electrical appliances Cars / Motorcycles Fluorescent lights Switch on PN-R in Picture menu to reduce picture noise
 Normal Picture	 No Sound	Volume level Sound mute switched on
 No Picture	 No Sound	TV set to AV mode Not plugged into A.C. outlet Not switched on Picture / Sound controls set at minimum levels Check if in standby mode
 No Colour	 Normal Sound	Colour controls set at minimum levels
 Poor or Distorted Picture	 Weak or No Sound	Retune Channel(s)
 Coloured Patches	 Normal Sound	Magnetic Interference from unshielded equipment Receiver moved while switched ON, switch TV off for 30 minutes.
 Normal Picture	 Weak or distorted sound	Sound reception may have deteriorated. Switch MPX setting (Sound menu) to Mono until reception improves.

FOR YOUR GUIDANCE

■ Service

Before requesting service, please refer to the troubleshooting guide on previous page to determine the symptoms. To obtain service please contact your local Panasonic dealer quoting the model number and serial number (both are located at the rear of the TV).

■ TV Games / Home Computers

Extended use of TV games or home computers with any television set can cause a permanent 'shadow' on the screen. This type of irreversible picture tube damage, can be limited by observing the following points:

- Reduce the brightness and contrast levels to a minimum viewing level.
- Do not operate the television set for a continuous period of time while using TV games or home computers.
- This type of picture tube damage, is not an operating defect, and as such is not covered by the Panasonic warranty.

■ Last Position Memory

Certain functions have a last position memory, i.e. the setting at the time of switch-off will be the setting used when the receiver is switched on again: –

Programme	Tint
OSD language	(M.NTSC / NTSC only)
AV Position	Contrast
Volume	Sharpness
MPX	Aspect
Bass	Standby
Treble	Artificial Intelligence (AI) (Picture & Sound)
Balance	Colour
Colour Balance	Brightness
Status	Ambience
P-NR	Teletext mode
Mode	Q-Link
Decoder (AV2)	

■ Sleep Feature

If the set is not switched off when the TV station stops transmitting, it will automatically go to standby mode after 30 minutes. This function will not operate when the TV is in AV mode.

SPECIFICATIONS

		TX-28SL1F	TX-25SL1F
Power Source		220 – 240V 50Hz A.C.	
Power Consumption		85W	85W
Standby Consumption		1.8W	
Picture Tube Visible Diagonal		66 cm	59 cm
Audio Output Music Power		2 x 15W, 8Ω impedance	
Dimensions	H	596.5 mm	550.5 mm
	W	778.0 mm	730.0 mm
	D	481.0 mm	478.5 mm
Weight (Kg)		32	27
Receiving Systems/ Band name		PAL B, G, H, I, SECAM B,G SECAM L/L' VHF E2 – E12 VHF A – H (ITALY) CATV (S01 – S05) CATV S11 – S20 (U1 – U10)	
		PAL D,K, SECAM D,K VHF R1 – R2 VHF R6 – R12	
		PAL 525/60 Playback of NTSC tapes from some PAL videorecorders (VCR) M.NTSC Playback from NTSC 4.43 MHz Videorecorders (VCR) NTSC (AV input only) Playback from NTSC Videorecorders (VCR)	
Aerial – Rear		UHF / VHF	
AV – Rear		AV1 – 21 pin terminal – Audio / Video in / out, RGB in. AV2 – 21 pin terminal – Audio / Video in/out, S-Video in, Q-Link 2 x RCA Audio Monitor Out.	

Specifications are subject to change without notice. Weight and dimensions shown are approximate.